



Self Priming Centrifugal Pump

Model 06D17-GAR

Size 6" x 4"

PUMP SPECIFICATIONS

Size: 6" (152 mm) Victaulic® Suction;
4" (102 mm) Petroleum Flange Discharge.

Casing: Aluminum 356-T6.
Maximum Operating Pressure 293 psi (2020 kPa).*

Enclosed Type, Eight Vane Impeller:
Aluminum Alloy 356-T6.
Handles 7/8" (22 mm) Diameter Spherical Solids.

Impeller/Pinion Shaft: Alloy Steel 8620.

Two Replaceable Wear Rings: Gray Iron 30.

Suction Head: Aluminum 356-T6.

Intermediate: Aluminum 356-T6.

Gearbox Housing: Gray Iron 30.

Gears: Alloy Steel 8620.

Gear Ratio: 2.18:1 Increaser.

Gearbox Lubrication: SAE 90 Gear Oil.

Bearings: Open Ball Type.

Gaskets: Vegetable Fiber and Cork.

Hardware: Standard Plated Steel.

Optional Equipment: Copper Alloy C83600 Wear Ring and Impeller.

**Consult Factory for Applications Exceeding Maximum Pressure and/or Temperature Indicated.*

Victaulic is a Registered Trademark of Victaulic Company of America.

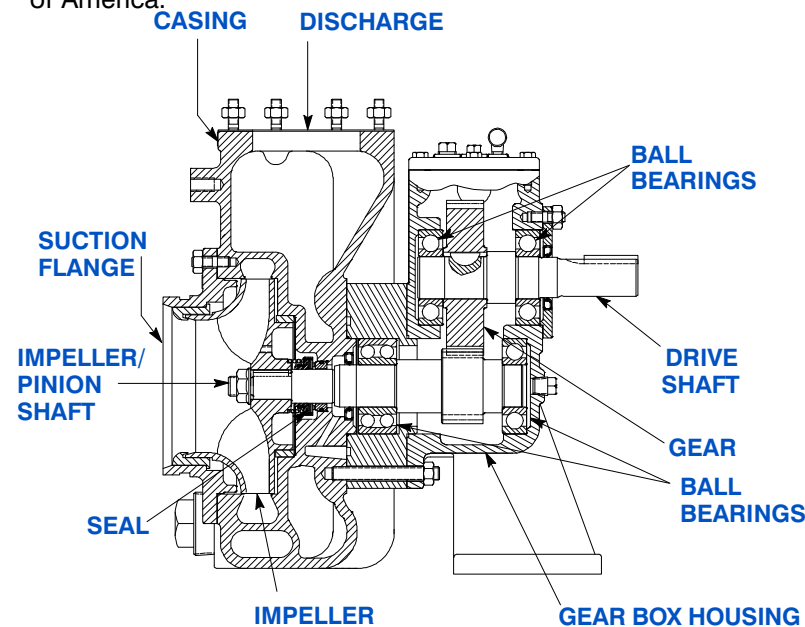
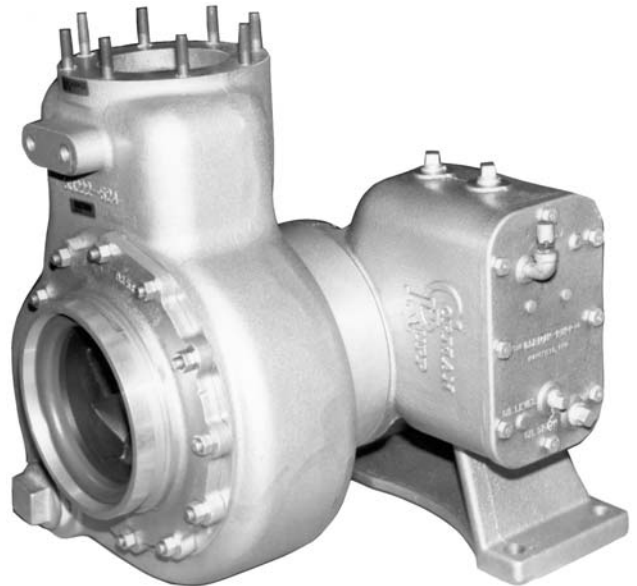

Rotation: Clockwise Facing Gearbox Input Shaft.

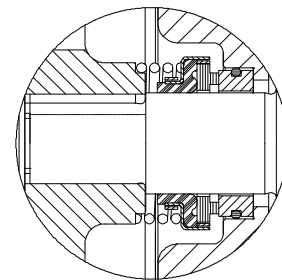

SEAL DETAIL

Type 2, Mechanical, Self-Lubricated. Carbon Rotating Face. Ni-Resist Stationary Face. Fluorocarbon Elastomers (DuPont Viton® or Equivalent). Stainless Steel 18-8 Cage and Spring. Maximum Temperature of Liquid Pumped, 160°F (71°C).*



GORMAN-RUPP PUMPS

www.grpumps.com

Specifications Subject to Change Without Notice

Printed in U.S.A.

Specification Data

OVERALL DIMENSIONS
and
APPROXIMATE WEIGHTS

NET WEIGHT: 131 LBS. (59 KG.)
SHIPPING WEIGHT: 136 LBS. (62 KG.)
EXPORT CRATE: 5.3 CU. FT. (0.15 CU. M.)

SECTION 110, PAGE 755

GEAR BOX DRIVE GEAR RATIO 2.18:1 INCREASE

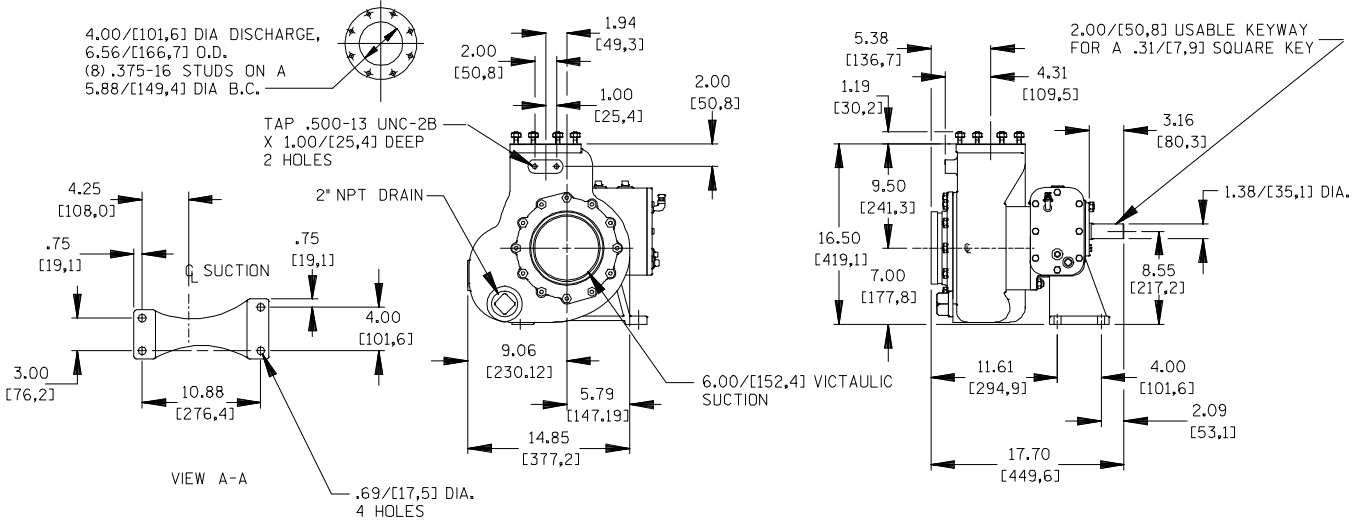

FOUR ALTERNATE GEARBOX LOCATIONS

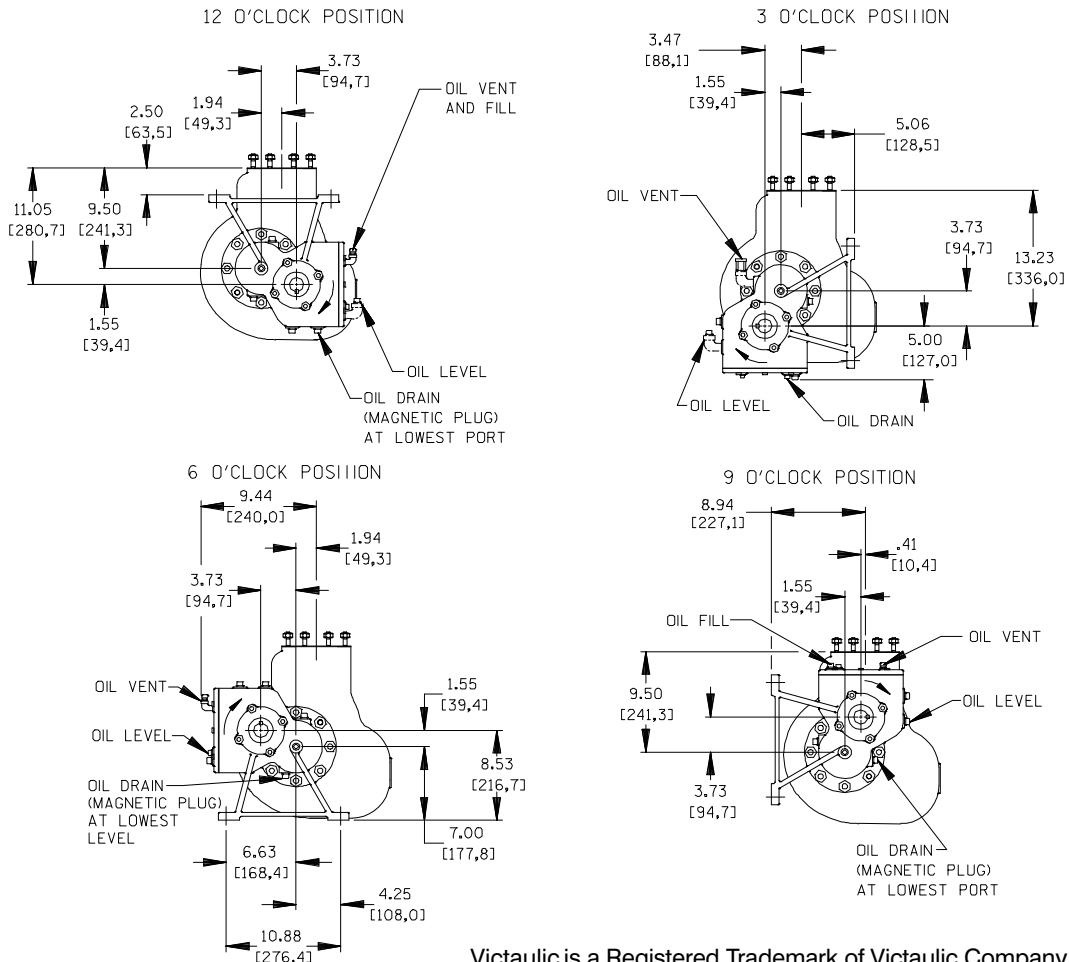

Victaulic is a Registered Trademark of Victaulic Company of America.



GORMAN-RUPP PUMPS

www.grpumps.com

Specifications Subject to Change Without Notice

Printed in U.S.A.

PERFORMANCE
BASED ON
PETROLEUM

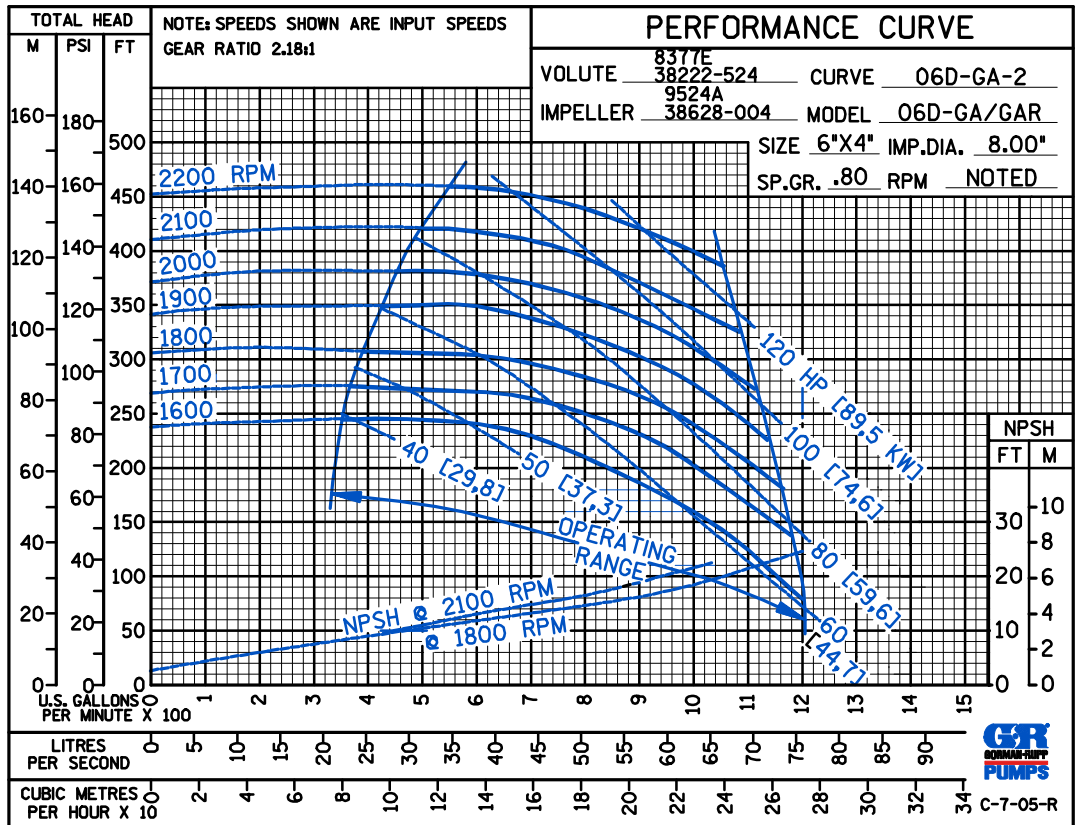

PERFORMANCE
BASED ON
WATER

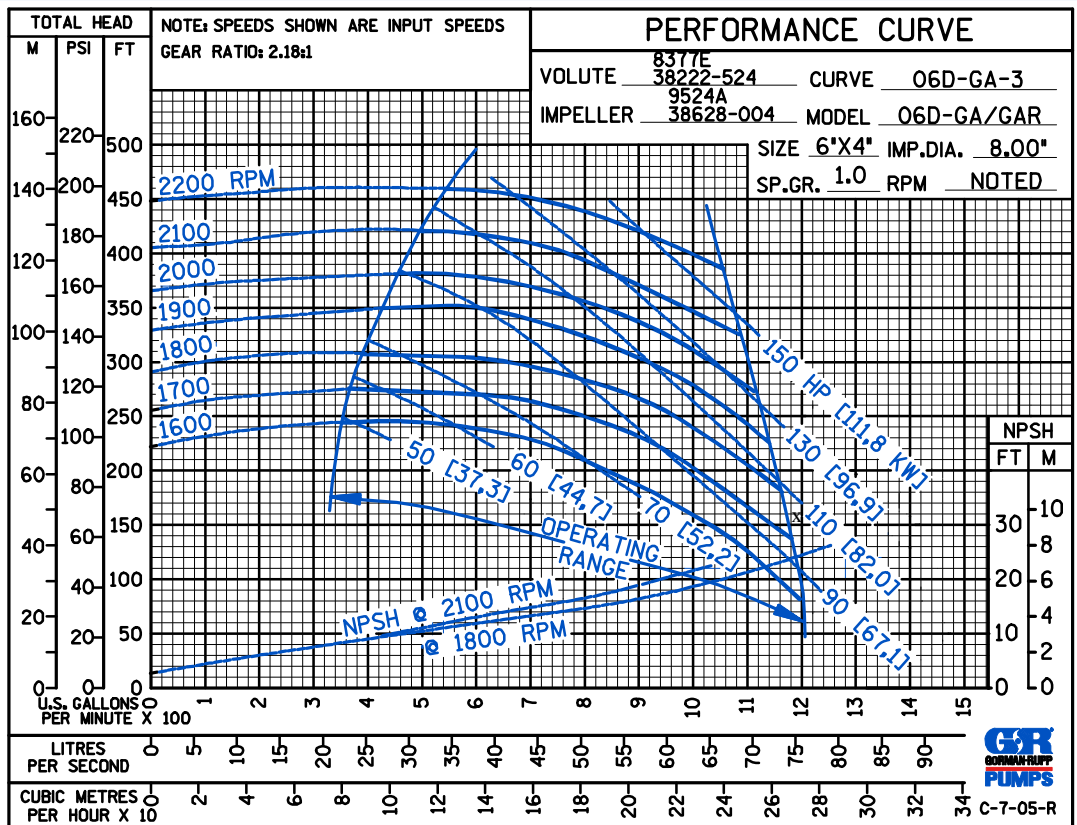

GORMAN-RUPP PUMPS

www.grpumps.com

Specifications Subject to Change Without Notice

Printed in U.S.A.